

PCT

WORLD INTELLECTUAL PROPERTY ORGANIZATION  
International Bureau



INTERNATIONAL APPLICATION PUBLISHED UNDER THE PATENT COOPERATION TREATY (PCT)

(51) International Patent Classification <sup>6</sup> : <b>A61B</b>		A2	(11) International Publication Number: <b>WO 98/24358</b>
			(43) International Publication Date: 11 June 1998 (11.06.98)
(21) International Application Number: PCT/US97/21747		(81) Designated States: AL, AM, AT, AU, AZ, BA, BB, BG, BR, BY, CA, CH, CN, CU, CZ, DE, DK, EE, ES, FI, GB, GE, GH, HU, ID, IL, IS, JP, KE, KG, KP, KR, KZ, LC, LK, LR, LS, LT, LU, LV, MD, MG, MK, MN, MW, MX, NO, NZ, PL, PT, RO, RU, SD, SE, SG, SI, SK, SL, TJ, TM, TR, TT, UA, UG, US, UZ, VN, YU, ZW, ARIPO patent (GI, KE, LS, MW, SD, SZ, UG, ZW), Eurasian patent (AM, AZ, BY, KG, KZ, MD, RU, TJ, TM), European patent (AT, BE, CH, DE, DK, ES, FI, FR, GB, GR, IE, IT, LU, MC, NL, PT, SE), OAPI patent (BF, BJ, CF, CG, CI, CM, GA, GN, ML, MR, NE, SN, TD, TG).	
(22) International Filing Date: 2 December 1997 (02.12.97)		<b>Published</b> <i>Without international search report and to be republished upon receipt of that report.</i>	
(30) Priority Data: 08/753,966 4 December 1996 (04.12.96) US 60/050,528 23 June 1997 (23.06.97) US			
(71) Applicant (for all designated States except US): ENACT HEALTH MANAGEMENT SYSTEMS [US/US]; Suite 306, 1975 E. Camino Real, West, Mountain View, CA 94040-2218 (US).			
(72) Inventors; and (73) Inventors/Applicants (for US only): HENSON, Eitan [US/US]; 1525 Siesta Drive, Los Altos, CA 94024 (US); TACKLIND, Christopher, A. [US/US]; 250 Cowper Street, Palo Alto, CA 94301 (US); SANDERS, Matthew, H. [US/US]; 23442 Toyonita Road, Los Altos Hills, CA 94024 (US).			
(74) Agents: KRUEGER, Charles, E. et al.; Townsend and Townsend and Crew LLP, 8th floor, Two Embarcadero Center, San Francisco, CA 94111 (US).			
(54) Title: SYSTEM FOR DOWNLOADING AND REPORTING MEDICAL INFORMATION			
(57) Abstract			
<p>A system for transferring binary medical files from remote devices to a central database over the internet includes an adapter for converting the binary medical information file to a compatible file of keystroke codes. The keystroke codes are transferred to a computer which converts the codes to ASCII characters which are input by an applet and transferred to the central database. Software at the central database recovers the original binary medical information file. Additionally, a system for accessing medical reports in real-time utilizes a report requesting page having a form for entering ID codes and report requesting data. The codes and data are transferred over the internet to a host computer which generates a report file and transfers the file via the internet to the requestor to be displayed on a computer.</p>			

BEST AVAILABLE COPY

*FOR THE PURPOSES OF INFORMATION ONLY*

Codes used to identify States party to the PCT on the front pages of pamphlets publishing international applications under the PCT.

AL	Albania	ES	Spain	LS	Lesotho	SI	Slovenia
AM	Armenia	FI	Finland	LI	Lithuania	SK	Slovakia
AT	Austria	FR	France	LU	Luxembourg	SN	Senegal
AU	Australia	GA	Gabon	LV	Latvia	SZ	Switzerland
AZ	Azerbaijan	GB	United Kingdom	MC	Monaco	TD	Chad
BA	Bosnia and Herzegovina	GE	Georgia	MD	Republic of Moldova	TG	Togo
BB	Barbados	GH	Ghana	MG	Madagascar	TL	Tajikistan
BD	Bangladesh	GN	Guinea	MK	Republic of Macedonia	TM	Turkmenistan
BE	Belgium	GR	Greece	ML	Mali	TR	Turkey
BG	Bulgaria	HU	Hungary	MR	Mauritania	TT	Trinidad and Tobago
BJ	Benin	IE	Ireland	MN	Mongolia	UA	Ukraine
BR	Brazil	IL	Israel	MR	Morocco	UG	Uganda
BY	Belarus	IS	Iceland	MW	Malawi	US	United States of America
CA	Canada	IT	Italy	MX	Mexico	UZ	Uzbekistan
CF	Central African Republic	JP	Japan	NE	Niger	VN	Viet Nam
CG	Congo	KE	Kenya	NI	Nicaragua	YU	Yugoslavia
CH	Switzerland	KG	Kyrgyzstan	NO	Norway	ZW	Zimbabwe
CI	Côte d'Ivoire	KP	Democratic People's Republic of Korea	NZ	New Zealand		
CM	Cameroon	KR	Republic of Korea	PL	Poland		
CN	China	KZ	Republic of Kazakhstan	PT	Portugal		
CU	Cuba	LC	Saint Lucia	RO	Romania		
CZ	Czech Republic	LI	Liechtenstein	RU	Russian Federation		
DE	Germany	LK	Sri Lanka	SD	Sudan		
DK	Denmark	LT	Lithuania	SE	Sweden		
EE	Estonia	LU	Luxembourg	SG	Singapore		



medical information file may include information related to glucose levels, blood pressure, etc. The public telephone systems of various countries are not standardized so different models would have to be built for different countries thereby increasing the overall cost of manufacturing the devices. Since low cost is critical to encourage widespread use of such devices the lack of telephone system compatibility is a serious problem to the internationalization of the technology.

Additionally, each device generally includes a front end to communicate results of a measurement to the user of the device, e.g., a patient or health care provider. Typically, a front end includes LEDs, a alpha-numeric display, synthetic voice output etc. The device may be coupled to a personal computer which would execute special software to operate as a front end.

#### Report Distribution System

A system for generating and distributing medical reports from a central database is described in the above-referenced patent application. Various formats including graphs and tables are described. Typically, these reports are delivered by fax, mail, or e-mail. However, none of these delivery systems facilitate real-time access of medical records by a requestor.

#### SUMMARY OF THE INVENTION

In one aspect of the present invention, the world-wide-web (WWW) is utilized as a universal front end for a medical monitoring device. Information from the device is communicated to a personal computer executing standard web browser software. A CGI form or applet, executed by the web browser software, receives the communicated information and functions as the front end of the device. Thus, a high-resolution personal computer display can be utilized as the front end of an inexpensive medical device.

According to another aspect of the invention, the WWW front-end includes a hot link to a personal physician or other health-care provider. The link includes a URL to a web

page of the doctor and transmits the medical information downloaded from a medical device.

According to another aspect of the invention, medical information received by the personal computer is communicated to the central database over the internet.

According to another aspect of the invention, an adapter formats the output of a medical device into an input format the can be processed by a page displayed by a web browser or by an applet executed by the web browser.

According to another aspect of the invention, medical reporting devices in different locations can be connected utilizing a home health-care bus. The devices can be coupled to the electrical wiring which is used to communicate information downloaded by the various devices to a central data handler.

According to one aspect of the present invention, a system is provided for utilizing the internet to transfer binary medical files between a remote health parameter monitoring device and a central database. Since the internet is platform independent it facilitates the standardization and internationalization of health monitoring systems.

According to a further aspect, a convertor is connectable to the device to receive a binary medical information file and convert the file to key codes to form a compatible medical information file. The key codes are transferred to a computer to be processed as keystroke data.

According to a still further aspect, a client workstation attached to the internet utilizes a browser to display a data transfer page embedding a data transfer applet. The data transfer applet accesses a keyboard buffer to input the encoded compatible file and transfer the encoded compatible file over the internet to the central database.

According to a still further aspect of the invention, the received encoded compatible file is decoded and decompatible at the central data base to recover the original binary medical information file.

According to another aspect of the invention, real-time access to medical reports is provided over the internet.

5 According to a further aspect, a report home page includes a form for accepting ID codes and report format information. The request information entered into the form is transferred over the internet to a request delivery server application operating on a host computer utilizing the common gateway interface (CGI) or an applet.

10 According to a further aspect of the invention, the report delivery software invokes report generating software at the central data base to generate the requested report in the form of either a text or graphics report file. The request delivery software formats the report file and transfers the formatted report file via the internet to the requestor to be displayed at the requestor's computer.

15 In one aspect of the present invention, the world-wide-web (WWW) is utilized to provide an enhanced interface to a medical monitoring device. Information from the device is communicated to a personal computer executing standard web browser software. A CGI form or applet, executed by the web browser software, receives the communicated information and functions as the front end of the device. Thus, a high-resolution personal computer display can be utilized as the front end of an inexpensive medical device. A result page generated by web server functions as the display of the medical measurement device. Additionally, the web page includes applets for controlling the device according to standard input, e.g, via mouse or keyboard, which is processed by the result page.

20 According to another aspect of the invention, medical reporting devices in different locations can be connected utilizing a home health-care bus in the form of the "Universal Serial Bus" (USB).

25 According to another aspect of the invention, a serial ID code is transferred to a remote data base server. The data base server responds to the code by providing data associated with the code. User specific data accessed by the

ID code is utilized to format the response for the particular user.

Other features and advantages of the invention will be apparent from the following detailed description and  
5 appended drawings.

#### BRIEF DESCRIPTION OF THE DRAWINGS

- Fig. 1A is a schematic diagram of first preferred  
embodiment of the invention;
- 10 Fig. 1B is a block diagram of a personal computer;
- Fig. 2 is a flow-chart depicting the steps for using  
a web browser as a front end of a medical measurement device;
- Fig. 3 is a schematic diagram depicting a home  
health-care bus;
- 15 Fig. 4A is a schematic diagram of a medical  
measurement device that downloads data to computer through an  
adapter;
- Fig. 4B is a flow-chart depicting the steps of  
converting a medical information file into a format compatible  
20 with a standard input to a personal computer;
- Fig. 5 is a diagram depicting a standard keyboard  
interface;
- Fig. 6A is a schematic diagram of an adapter;
- 25 Figs. 6B and 6C are diagrams depicting a specific  
embodiment of an adapter;
- Fig. 7 is a flow-chart depicting the steps of  
transferring a compatible medical information file over the  
internet;
- 30 Fig. 8 is a schematic diagram of a system for  
transferring medical reports over the internet; and
- Fig. 9 is a flow-chart depicting the steps of  
transferring medical reports over the internet.

#### DETAILED DESCRIPTION OF THE PREFERRED EMBODIMENTS

Fig. 1A is a block diagram of a preferred embodiment of virtual front end utilizing standard web-browser software. In Fig. 1A, a medical device 10 includes an infrared (IR) transmitter for transmitting medical measurement data, modulated onto an IR carrier, to the IR input of a personal computer 30. In the following the term personal computer will be utilized to refer to any device, such as WebTV or other web appliances, that can be used to access the internet. The transmitted medical measurement data is transmitted in the form of keyboard data (as described more fully below) before being modulated onto the IR carrier. The IR transmitter and IR keyboard interface are standard, well-known parts and are not part of the present invention. The IR keyboard interface directly serves a variety of input devices such as, for example, a keyboard, mouse, AIRWATCH, thermometer, range of motion sensors, barcode reader, scale, height measurement, blood pressure cuff, tympanic compliance, mag stripe writer, tag writer, printer, and printer for wrist band.

Fig. 1B is a block diagram of a typical personal computer and connected peripheral device. The CPU executes programs which may be provided from the hard-disk drive (HDD), floppy-disk drive (FDD), from the serial port, or from other sources. Typically, a computer is connected to the internet via a modem connected to the serial port.

The personal computer executes standard web-browser software, e.g., Netscape Navigator, America On Line, or Microsoft Internet Explorer. The World Wide Web (WWW) is a network for connecting computers via the internet. Typically, a client computer executes a browser application that allows a user to access documents from any site on the WWW. Documents in hypertext mark-up language (HTML) include links to other HTML documents, graphics and sound files, executable applications, etc. In some cases an HTML document includes executable code, scripts, embedded within the document. In other situations an applet, for example a Java applet, is referenced within an HTML document and downloaded from a server to execute on the client computer displaying the HTML document with the browser application.



Forms may be included in HTML pages. Data is entered into a form through the keyboard and transmitted to a server application utilizing the common gateway interface (CGI). A program resides on the server that receives the information from the form and returns appropriate data. The types of information that can be exchanged includes text data and binary files such as GIF images.

In one embodiment, depicted in the flow-chart of Fig. 2, a front-end home page is displayed by the web-browser. The URL of the front-end home page can be stored as a bookmark or favorite place.

The compatible medical data is accepted by a form included in the front-end home page and transmitted to a server application executing on a host computer 32 (Fig. 1A) using the common gateway interface (CGI). The server application generates a page displaying the test results and transmits the test results page to the web-browser. The web-browser then displays the results to the user.

Alternatively, the compatible medical data can be input to a Java applet executed by the browser software. The Java applet formats a results image which is displayed by the web-browser. In the interest of security, the I/O of a Java applet is restricted. For example, Java applets cannot read or write files on the client computer executing the applet. Additionally, the browser application limits an applet's network connectivity. An applet's network connectivity is currently limited to its host machine. However, a Java applet can input keyboard data entered through the keyboard of the client machine.

Regardless of whether the results page is generated by the server or a Java applet, the results page can include a hot link to the web page of a personal physician or other health-care provider. By clicking on the link the results of a medical measurement is transmitted over the internet to the physician's computer 34 (Fig. 1A). A internet link between the computers 30 and 34 of the patient and physician facilitates real time-health care monitoring. For example, after reviewing the results of a measurement the physician

might suggest retrying measurement under the same or different conditions.

Additionally, as depicted in Fig. 1A and described more fully below, the compatible medical data can be transmitted to the central database 36 (Fig. 1A) utilizing the CGI or a Java applet. The compatible medical data is received at the server which decodes the compatible medical data and transfers the decoded data to a central database 36 which integrates the decoded data into the database 36.

In Fig. 1A, a device utilizing an IR transmitter is depicted. If the device were in a different room than the user's computer then the device could not transmit data because IR transmission is limited to line-of-sight. Accordingly, if the device were heavy or immobile, such as a scale, or if multiple devices were located throughout the home an IR interface to the computer would not be practical.

However, as depicted in Fig. 3, various medical measurement devices throughout the home can be connected to a home healthcare bus. In a preferred embodiment, information from each device 10A and 10B is coupled to the home wiring system 300 and is transmitted to a data center 302 via the wiring system. The data is transmitted over the home wiring system utilizing interfaces well-known in the art. Alternatively, special wires, cable, IR repeaters, radio-frequency, or fiber could be utilized to form the bus. The data center 302 includes an interface, for example an IR transmitter, for providing encoded keyboard data to the personal computer.

Alternatively, the medical devices, web appliance, telephone, and other peripheral are connected to the "Universal Serial Bus" (USB). The USB provides a standard to merge desktop connections. USB compliant medical monitors 10A and 10B have USB interface connectors, e.g., the type B connector is identical in size to an RJ-11 socket. The monitors is connected directly to any USB computer or web appliance through a generic cord.

As described in the above-referenced '117 patent, the medical measurement device may be interface to the

telephone line via a reported device which formats measured data and interfaces with the central data base. In the USB embodiment, the reporter may function in two modes.

5 In a first mode, the monitor downloads measurement data and the reporter interfaces with the central database through the USB bus. In the second interactive mode, the reporter establishes a live connection between the monitor and central server. This allows the reporter to be generic and the server interrogates the monitor directory. The reporter  
10 does not need to know anything specific about the particular connected monitor and the server can then be continuously extended to talk to new devices without changing the reporter.

The device of Fig. 1A outputs medical information data encoded as keyboard data which can be received by the  
15 keyboard interface of the personal computer. Thus, the medical device could generated medical measurement files in format compatible with a keyboard or other PC input port. Alternatively, medical information data in binary or any other incompatible format could be output by the device to an  
20 adapter. The adapter is designed to convert the data output by the device to encoded keyboard data which can be received by the keyboard interface of the computer. A system utilizing an adapter will now be described. In the following the adapter is a stand-alone device which is connected to the  
25 output of the medical measurement device. Alternatively, the adaptor could be integrated into the device.

Fig. 4A is a system level diagram of another preferred embodiment of the invention. In Fig. 4A, a medical monitoring device 10 outputs a binary medical information  
30 file. As described below, this file may be in the form of analog signals modulated on a carrier frequency or as a digital signal output by a digital interface.

The operation of the system will now be described with reference to Fig. 4A and flow chart of Fig. 4B. The  
35 binary file is transferred to an adapter 400 which receives the binary file and converts the file into a compatible medical file in a format that may be processed and decoded by the standard keyboard interface of a personal computer 30. In

the compatible medical file each byte of the medical file is replaced by a scan code comprising ASCII characters which are written to a keyboard buffer as an compatible medical information file. Thus, there is a correspondence between words in the binary medical file and ASCII characters which are stored in the keyboard buffer.

The patient's personal computer 30 is connected to the World Wide Web on the Internet and executes a browser application. An applet or CGI form, invoked by the browser application, reads keystroke ASCII codes from the keyboard buffer and transfers the ASCII codes to a server application. The server application processes the received ASCII codes to reconstruct the original binary medical file which is then processed by software at the server to generate a result page to be displayed by the PC 30 or to store the received medical information in a database 36.

The result web page generated by the server can be formatted to function as an enhanced user interface. For example, the AIRWATCH (described above) includes an LED interface for displaying time, date, personal best data, etc., and includes buttons for controlling monitor functions. As monitors get smaller and more complicated the process of controlling each function of the device with small buttons and a small display gets difficult.

However, if the monitor is connected to web, via the USB for example, then the web server can generate a result page for display on web appliance monitor that includes formatted display of the monitor output parameters and software buttons for controlling the monitor function.

As an example, for the AIRWATCH, the personal best and other data are displayed one at a time. The right and left buttons move to the next digit to the right or left. In an enhanced interface the entire line of parameters would be displayed stretching across the result page. With the standard mouse and keyboard interface any digit could be selected directly and a pop out list used to select the desired value.

Once a monitor is connected to the web, the ID code is provided to the server and functions as a hardware key allowing access to the data on the server associated with that device.

5           The server responds to the ID by checking user-specific data which describes attributes of the user such as age and native language. The server formats a response page in a manner appropriate to the particular user. Viewing preferences can be saved and recalled during a next session.

10           Hardware key recognition can be utilized in connection with conventional typed in data such as passwords. If a logging monitor is used by more than one family member a "user selector" indicates to the web application which family member's data is to be displayed.

15           Similarly, when a connection is established from a doctor's office, the database server recognizes the device and the doctor (by his web login). The connection to the database is authorized and information is displayed appropriately.  
PC Keyboard Controller and ISR

20           The structure of the keyboard 500 and keyboard interface 510 for a PC is depicted in Fig. 5. This configuration is well-know and will be only briefly described. When a key is pressed a scan code, in the form of ASCII codes, unique to the key is generated by the keyboard chip 502 and is  
25           serially transferred to the keyboard interface 510 by the keyboard cable 520. The serial data is converted to a parallel byte so that the scan code can be processed by the MPU.

30           The scan codes are received by the PC and translated to ASCII codes utilizing a Keyboard Interrupt Service Routine (ISR) included in the Basic I/O System (BIOS). The ISR is invoked by INT 09 each time a key is pressed and converts keyboard data into information that is useful to the system. This conversion results in the Keyboard ISR placing a two-byte  
35           character code into a keystroke buffer in the PC's memory.

          Typically, the keyboard ISR in a PC/AT system converts the codes received into System Scan Codes. These System Scan Codes are then compatible into the two-byte

character codes having a low-order byte, called the main byte, and a high-order byte, called the auxiliary byte. The ASCII value of a key-stroke (if any) is always contained in the main byte and the scan code as the auxiliary byte. When a key, such as a function key, edit key, or function key combination, does not have an ASCII value, then the Keyboard ISR sets the main byte to 00h and the auxiliary byte to a special key value.

A BIOS Keyboard Device Service routines provides an interface through which the operating system or application software can interface with the keyboard buffer.

#### The Adapter

Fig. 6A is a block diagram of the adaptor 400 which includes a device interface 402, processor 410, and serial interface 420. If the medical device 10m utilizes a modem to output a modulated carrier signal encoding the binary medical file then the device is connected to a modem interface in the device interface 402. If the medical device 10s has a serial output then it is connected to a serial interface in the device interface 402. A specific device interface 402 may have either a modem, serial interface, or combination of the two.

A processing unit 410 converts the words of the binary medical information file to scan codes and transfers the scan codes to the keyboard serial interface 420. The conversion of the words in the binary medical information to scan codes is accomplished utilizing standard techniques, e.g., a look-up-table.

The keyboard serial interface 420 transfers the scan code serially to the keyboard controller on the PC as described above. The keyboard serial interface 420 is a pass-through connection that passes the output from the connected keyboard to the PC when a medical device 10 is not connected to the adapter.

A specific embodiment of a prototype adapter 500 is depicted in Figs. 6B and 6C. In Fig. 6B a device having an output modulated by a modem is coupled to the adapter 500

through a standard RJ-11 jack. A telephone simulator couples the binary medical file to an HP Palmtop computer through a PCM-CIA modem 620. A wedge circuit controllably couples either the keyboard or Palmtop output to the PC.

5           The operation of the adaptor 500 will now be described for the case where an AIRWATCH respiratory function monitor is coupled to the adaptor. The data interface to the AIRWATCH specifies a 5 byte serial number, a packet list including a header, 128 bytes of packet data, and 2 bytes of  
10          CRC (cyclic redundancy checking).

          The adapter 500 auto-answers AIRWATCH initiated downloads and send the AIRWATCH data over the IBM PC keyboard prot as if typed on a "virtual" keyboard. Each byte of the AIRWATCH data is converted to 2 ASCII hex nibbles. Thus, for  
15          example a byte having hex value 0x1A is represented as if the two-character ASCII string "1A" was typed on the keyboard. In this embodiment the adapter 500 does not perform any CRC or error checking, it simply converts and passes along data that it receives.

20           As described above, the I/O options of Java applets are limited by security considerations. One such limitation is that the Java output cannot output data through the keyboard interface. For medical devices requiring an acknowledge signal or other handshaking, the adapter is not  
25          able to provide the required information. Accordingly, the server application can display an acknowledge which must be provided to the device by the user.

#### Internet Transfer of Medical Records

30           Referring to Figs. 1 and 7, a process for transferring medical information from a medical measuring device to a central database 36 will now be described. Referring to the flow-chart of Fig. 7, a browser application, running on the user's computer, utilizes a designated URL to  
35          access data transfer page over the internet. As described above, the designated URL may be automatically provided when a medical device 10 is coupled to the adapter 20.

The data transfer page includes an embedded data transfer applet, which in a preferred embodiment is a Java applet. The applet is executed on the user's computer and inputs the converted medical file from the keyboard buffer and transmits the file to the host computer 32.

Alternatively, as described above, the data transfer page can include a form that transmits converted medical data to the host 32 utilizing the CGI.

The host computer host decodes the converted medical file to change the ASCII codes to corresponding bytes of the medical information file.

The medical information file is in a form that is processed by database software to update the medical database 36.

#### Internet Delivery System

A system for utilizing the internet to deliver medical reports in real-time will now be described with reference to Figs. 8 and 9. Typically, the reports are computer generated from records in a central database and are formatted either as text or graphics files. Additionally, the reports can be formatted as faxes, letters, etc. An example of a central database is described in the '117 patent and includes information downloaded over the telephone system from AIRWATCH devices.

A report requester utilizes a browser executing on a client computer 30 to access a report request page by supplying a designated URL.

The host computer 32 generates a report request HTML document including a FORM to allow feedback from a client computer displaying the report request document using a browser application.

The report requester enters passwords for accessing a particular patient's records. The requestor also indicates the desired format of the report, e.g., a graph, table, or other format. When the requestor completes filling out the form the information entered is transferred to the form



reporting server application executing on the host computer 32  
utilizing the common gateway interface (CGI).

5 A form reporting server application invokes a report  
delivery script which first checks the codes to confirm that  
the requester is authorized to access the records. The script  
then invokes report generating software which generates a  
report file.

10 If the report file is a text file then the report  
delivery script converts the file to an HTML report file and  
transfers the report file to the client computer to be  
displayed by the browser application. If the report file is a  
graphics file it is converted by the report delivery script  
15 into a graphics file type that can be displayed by the browser  
or a browser helper application or plug-in and transfers the  
compatible graphics report file to the client computer to be  
displayed by the browser application.

20 In a preferred embodiment, the report files are  
Postscript® files which are converted by the server report  
delivery software to GIF files before transfer to the client  
computer. Formats of reports are depicted in the above-  
referenced patent application.

Alternatively, an interactive requestor user  
interface can be implemented utilizing a Java applet.

25 Thus, physicians, health officials, and other  
medical personnel have real-time access to database records  
stored at a central location.

30 The invention has now been described with reference  
to the preferred embodiments. Alternatives and substitutions  
will now be apparent to persons of skill in the art. For  
example, the keyboard interface of a PC has been described.  
However, the principles of the invention are equally  
applicable to other platforms including Macintosh® and UNIX.  
Further, the preferred embodiment utilizes the WWW. Again,  
35 other network implementations are within the scope of the  
invention. Accordingly, it is not intended to limit the  
invention except as provided by the appended claims.

WHAT IS CLAIMED IS:

1                   1.    An adapter for connecting a medical device to a  
2    client computer, with the medical device of the type that  
3    outputs a digital medical file organized into one or a  
4    plurality of words including digital medical measurement data,  
5    a modulating system for converting the digital medical file  
6    into analog signals for to transmission over the telephone  
7    lines to a central location, and with the client computer  
8    having a keyboard connector for receiving keyboard input in  
9    the form of key codes generated by the keyboard and executing  
10   a browser application which displays a data transfer page  
11   generated by a host computer and inputs said key codes and  
12   transmits the key codes to the host computer, said adapter  
13   comprising:

14                   a demodulating unit, coupled to the modulating  
15   system of said medical device, for demodulating the  
16   transmitted analog signals to recover said digital medical  
17   file;

18                   a conversion unit for converting each word of a  
19   recovered digital medical file to a corresponding key code;  
20                   an interface, connectable to said keyboard  
21   connector, for emulating a keyboard and transferring said  
22   corresponding key codes to be processed as keyboard data by  
23   said client computer so that the data transfer page can input  
24   the corresponding key codes and transmit the corresponding key  
25   codes to the host computer for processing.

1                   2.    A system for connecting a medical device to a  
2    central database, said system comprising:

3                   a host computer, connected to a network and  
4    executing a server program that receives key codes and  
5    converts the codes to corresponding words to reconstruct a  
6    digital medical file encoded by the key codes received, and  
7    for providing a reconstructed medical file to a central  
8    database;

9                   a client computer, connected to a network and having  
10   a keyboard connector for receiving keyboard input in the form

11 of key codes generated by the keyboard and executing a browser  
12 application which displays a data transfer page generated by  
13 the host computer and that inputs said key codes and transmits  
14 the key codes to the server program executing on the host  
15 computer;

16 an adapter for connecting a medical device to a  
17 client computer, with the medical device of the type that  
18 outputs a digital medical file organized into one or a  
19 plurality of words including digital medical measurement data,  
20 a modulating system for converting the digital medical file  
21 into analog signals for to transmission over the telephone  
22 lines to a central location, and with the client computer  
23 having a keyboard connector for receiving keyboard input in  
24 the form of key codes generated by the keyboard and executing  
25 a browser application which displays a data transfer page  
26 generated by a host computer and inputs said key codes and  
27 transmits the key codes to the host computer, said adapter  
28 comprising:

29 a demodulating unit, coupled to the modulating  
30 system of said medical device, for demodulating the  
31 transmitted analog signals to recover said digital  
32 medical file;

33 a conversion unit for converting each word of a  
34 recovered digital medical file to a corresponding key  
35 code;

36 an interface, connectable to said keyboard  
37 connector, for emulating a keyboard and transferring said  
38 corresponding key codes to be processed as keyboard data  
39 by said client computer so that the data transfer page  
40 can input the corresponding key codes and transmit the  
41 corresponding key codes to the host computer for  
42 processing.

1 3. An adapter for connecting a medical device to a  
2 client computer, with the medical device of the type that  
3 outputs a digital medical file organized into one or a  
4 plurality of words including digital medical measurement data,  
5 a modulating system for converting the digital medical file

6 into analog signals for to transmission over the telephone  
7 lines to a central location, and with the client computer  
8 having a keyboard connector for receiving keyboard input in  
9 the form of key codes generated by the keyboard and executing  
10 a browser application which displays a data transfer page  
11 generated by a host computer and inputs said key codes and  
12 transmits the key codes to the host computer, said adapter  
13 comprising:

14 a conversion unit for converting each word of an  
15 output digital medical file to a corresponding key code; and  
16 an interface, connectable to said keyboard  
17 connector, for emulating a keyboard and transferring said  
18 corresponding key codes to be processed as keyboard data by  
19 said client computer so that the data transfer page can input  
20 the corresponding key codes and transmit the corresponding key  
21 codes to the host computer for processing.

1 4. A system for connecting a medical device to a  
2 central database, said system comprising:

3 a host computer, connected to a network and  
4 executing a server program that receives key codes and  
5 converts the codes to corresponding words to reconstruct a  
6 digital medical file encoded by the key codes received, and  
7 for providing a reconstructed medical file to a central  
8 database;

9 a client computer, connected to a network and having  
10 a keyboard connector for receiving keyboard input in the form  
11 of key codes generated by the keyboard and executing a browser  
12 application which displays a data transfer page generated by  
13 the host computer and that inputs said key codes and transmits  
14 the key codes to the server program executing on the host  
15 computer;

16 an adapter for connecting a medical device to the  
17 client computer, with the medical device of the type that  
18 outputs a digital medical file organized into one or a  
19 plurality of words including digital medical measurement data,  
20 a modulating system for converting the digital medical file  
21 into analog signals for to transmission over the telephone

22 lines to a central location, and with the client computer  
23 having a keyboard connector for receiving keyboard input in  
24 the form of key codes generated by the keyboard and executing  
25 a browser application which displays a data transfer page  
26 generated by a host computer and inputs said key codes and  
27 transmits the key codes to the host computer, said adapter  
28 comprising:

29           a conversion unit for converting each word of a  
30 digital medical file to a corresponding key code;  
31           an interface, connectable to said keyboard  
32 connector, for emulating a keyboard and transferring said  
33 corresponding key codes to be processed as keyboard data  
34 by said client computer so that the data transfer page  
35 can input the corresponding key codes and transmit the  
36 corresponding key codes to the host computer for  
37 processing.

1           5. A system for connecting a medical device to a  
2 central database, said system comprising:

3           a host computer, connected to a network and  
4 executing a server program that receives key codes and  
5 converts the codes to corresponding words to reconstruct a  
6 digital medical file encoded by the key codes received, and  
7 for providing a reconstructed medical file to a central  
8 database;  
9           a client computer, connected to a network and having  
10 a keyboard connector configured to receive keyboard input in  
11 the form of key codes generated by the keyboard and executing,  
12 said client computer for receiving a medical information file  
13 from the medical device formatted as key codes and executing a  
14 browser application which displays a data transfer page  
15 generated by the host computer and that inputs said key codes  
16 of the medical information file and transmits the key codes to  
17 the server program executing on the host computer.

1           6. A system for delivering medical reports  
2 generated at a central location and utilizing information  
3 stored in a central database, said system comprising:

4 a client computer, connected to a network, executing  
5 a browser application displaying a report requesting document  
6 for transferring, over the network password information and  
7 request format information to a report generating server  
8 application;

9 a host computer, connected to the network, executing  
10 said report generating server application, with said report  
11 generating server application for invoking report generating  
12 software to generate a report file in a browser compatible  
13 format, and for transferring the report file to the client  
14 computer over the network to be displayed by the browser  
15 application executing on the client computer.

1 7. A system for implementing a universal front-end  
2 for a medical measurement device, said system comprising:

3 a personal computer, connected to a network and  
4 including standard I/O ports and a display device;

5 a data output interface, coupled to a medical  
6 measurement device, for providing compatible medical  
7 information data including medical information in a digital  
8 format compatible with a standard input port of said personal  
9 computer;

10 a processor included in said personal computer,  
11 executing web-browser software to display a front-end page and  
12 configured to process received medical information data  
13 provided by said medical measurement device and to display the  
14 results of a medical measurement utilizing the display device.

1 8. The system of claim 7 where said data output  
2 interface provides compatible medical information in the form  
3 of key codes compatible with a keyboard interface of a  
4 personal computer.

1 9. A system for providing medical measurement  
2 information output by a medical measurement devices to a  
3 central database, said system comprising:

4 a host computer, connected to a network and  
5 executing a server program and database software for receiving

6 medical information data encoded in an output format utilized  
7 by web-browser applications, said host computer configured to  
8 process received medical information data to enter medical  
9 information into said database;

10 a client computer, connected to a network and  
11 including standard I/O ports and a display device;

12 a data output interface, coupled to a medical  
13 measurement device, for providing compatible medical  
14 information data including medical information in a digital  
15 format compatible with a standard input port of said personal  
16 computer; and

17 a processor included in said personal computer,  
18 executing web-browser software to display a data-communication  
19 page and configured to process received medical information  
20 data provided by said medical measurement device, and to  
21 transfer received medical information data over a network to  
22 said host computer.

1 10. A system medical information management system  
2 for receiving medical information measured by a plurality of  
3 medical measurement devices and providing the information to a  
4 personal computer, said system comprising:

5 a bus, having a plurality of input ports for  
6 coupling to one of the medical devices; and

7 a data collector, coupled to said bus, and including  
8 a data output interface, for providing compatible medical  
9 information data, including medical information received from  
10 each input port of said bus, converted to a digital format  
11 compatible with a standard input port of the personal  
12 computer.

1 11. The system of claim 10 wherein:  
2 said bus is the wiring system of a home.

1 12. A system for implementing a universal front-end  
2 for a medical measurement device, said system comprising:  
3 a personal computer, connected to a network and  
4 including standard I/O ports and a display device;

5 a data output interface, coupled to a medical  
6 measurement device, for providing compatible medical  
7 information data including medical information converted to a  
8 digital format compatible with a standard input port of said  
9 personal computer;

10 a processor included in said personal computer,  
11 executing web-browser software to display a front-end page and  
12 configured to process received medical information data  
13 provided by said medical measurement device, to transmit said  
14 information over the network to a health-care provider.

1 13. The system of claim 12 wherein:  
2 said processor is further configured to establish a  
3 connection over the network to facilitate real-time  
4 communication between a health-care provider and a patient  
5 concerning the results of a medical measurement.

1 14. A system for implementing an enhanced interface  
2 for a medical measurement device, said system comprising:  
3 a web appliance, connected to a network and  
4 including standard I/O ports and a display device;

5 a data input/output interface, coupling the medical  
6 measurement device and the web appliance, for transmitting  
7 compatible information data, from the medical measurement  
8 device, in a digital format compatible for processing by said  
9 web appliance and for transmitting medical measurement device  
10 control information from the web appliance to the medical  
11 measurement device;

12 a processor included in said web appliance,  
13 executing web-browser software to display a front-end page and  
14 configured to process information data provided by said  
15 medical measurement device and to display a result page  
16 displaying parameter values relating to the operation of the  
17 medical device and for displaying interactive function keys to  
18 activate functions in the medical device.



1           15. A system for implementing a hardware key for a  
2 medical measurement device to gain access to a remote  
3 database, said system comprising:

4           a web appliance, connected to a network and  
5 including standard I/O ports and a display device;

6           a data output interface, coupled to a medical  
7 measurement device, for providing medical measurement device  
8 identification data to said web appliance;

9           a remote database server coupled to the web, said  
10 database server for providing user data when a identification  
11 data associated with a user is received;

12           a processor included in said web appliance,  
13 executing web-browser software to display a front-end page and  
14 configured to transfer said medical identification data  
15 provided by said medical measurement device to said remote  
16 database server to gain access to data associated with a user  
17 of said medical measurement device.

1           16. A system medical information management system  
2 for receiving medical information measured by a plurality of  
3 medical measurement devices and providing the information to a  
4 personal computer, said system comprising:

5           a universal serial bus, having a plurality of  
6 input/output ports for coupling to one of the medical devices;

7           a web appliance coupled to the universal serial bus,  
8 with the web appliance with the web appliance including a  
9 executing web-browser software to display a front-end page and  
10 configured to process information data provided by said  
11 medical measurement device and to display a result page;

12           a telephone connection for connecting a medical  
13 device to a remote central data base.

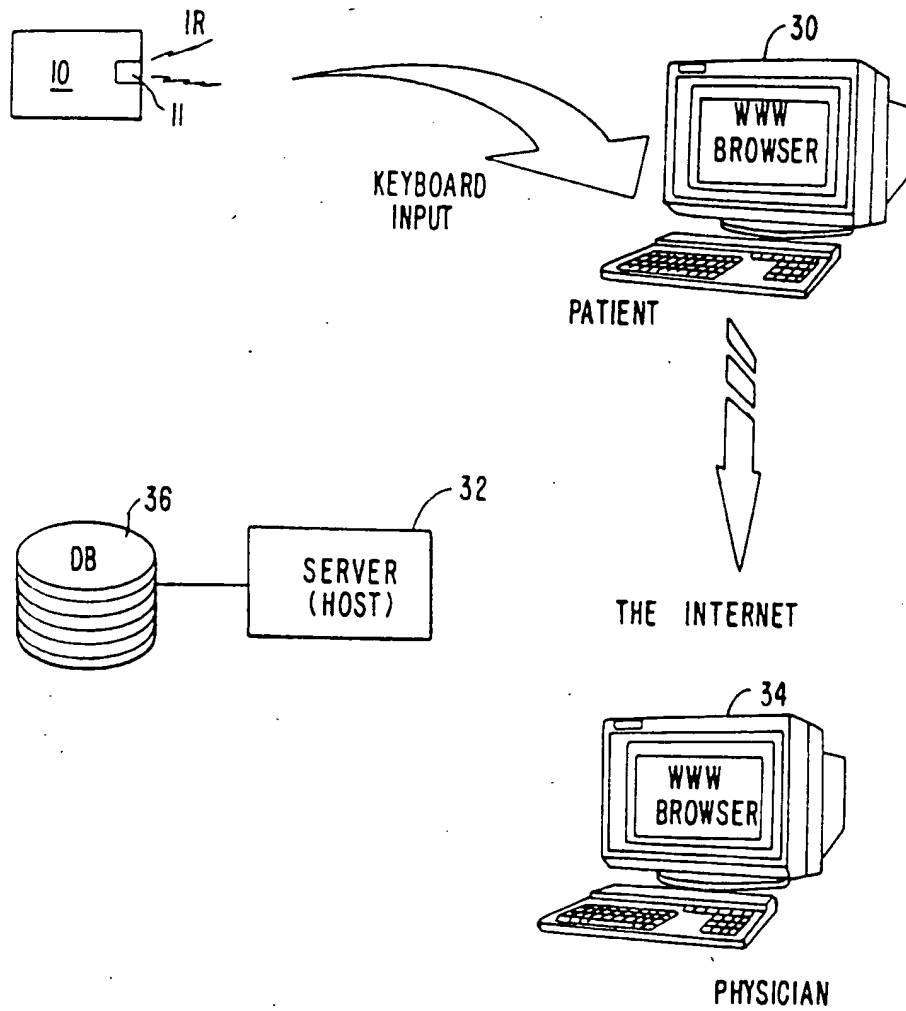
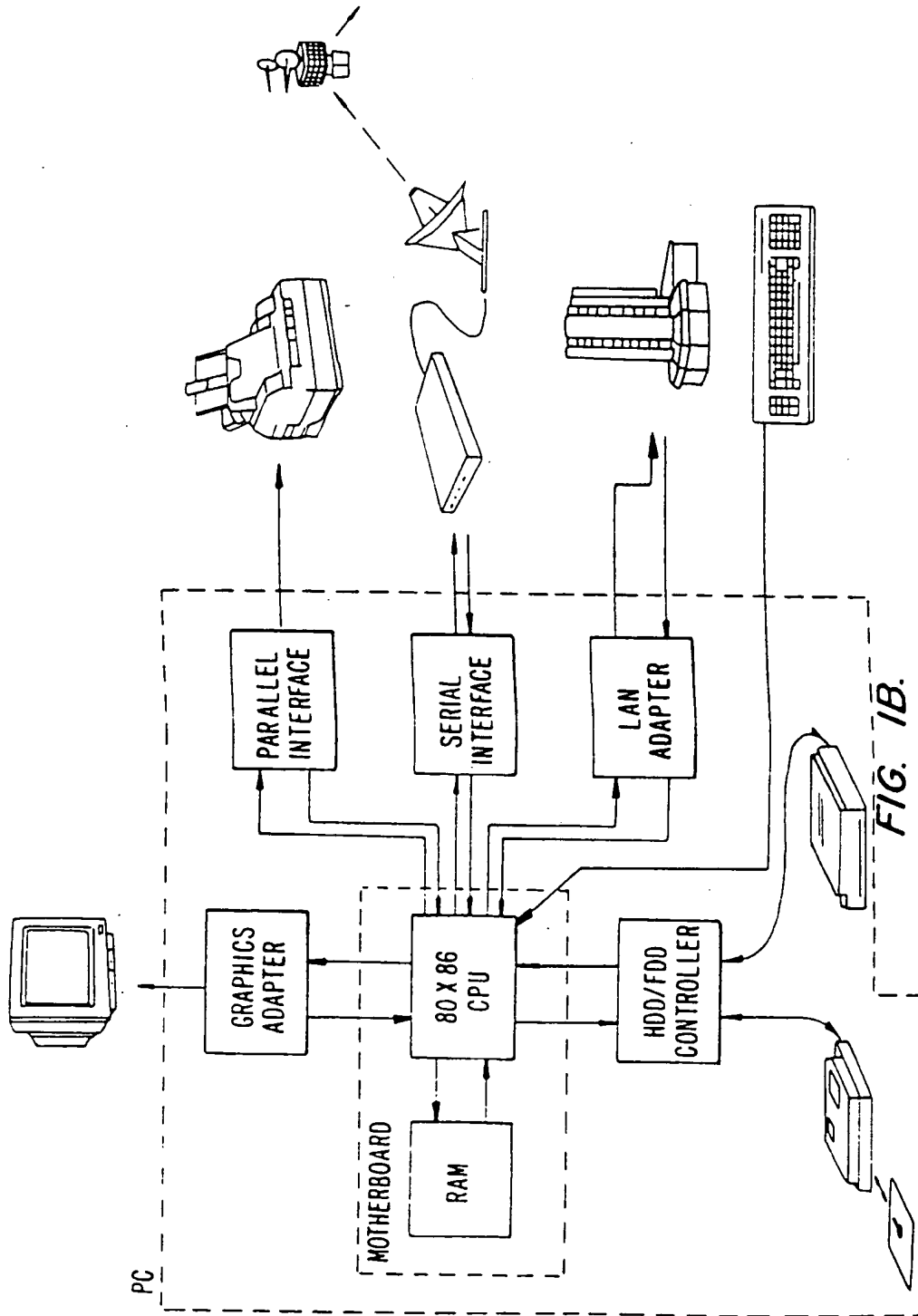

FIG. 1A.



3/11

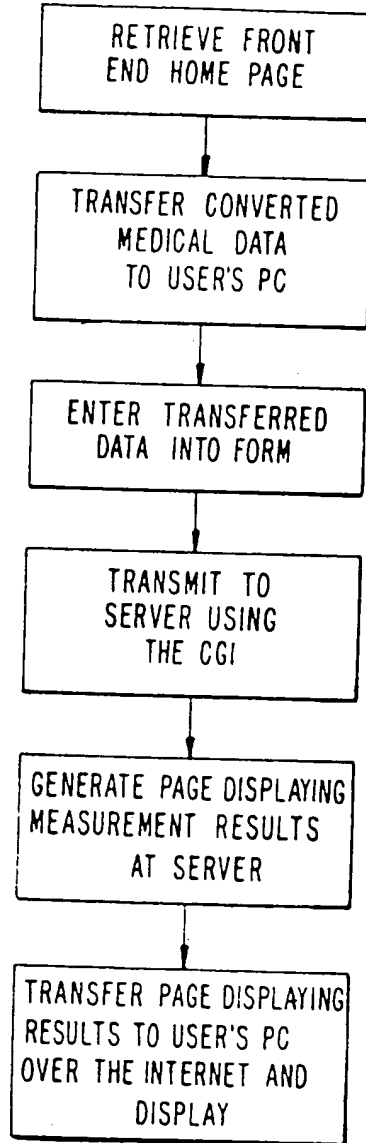

FIG. 2.

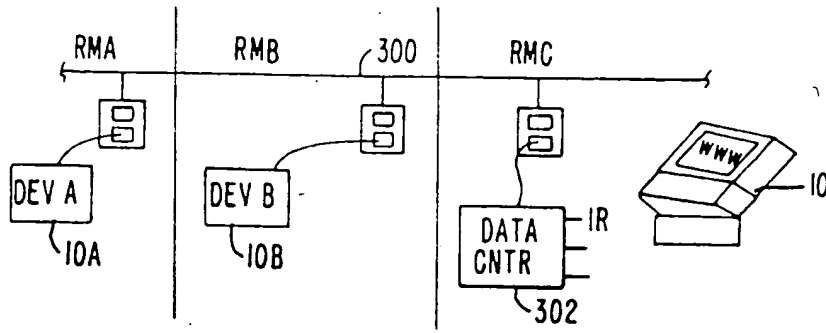

FIG. 3.

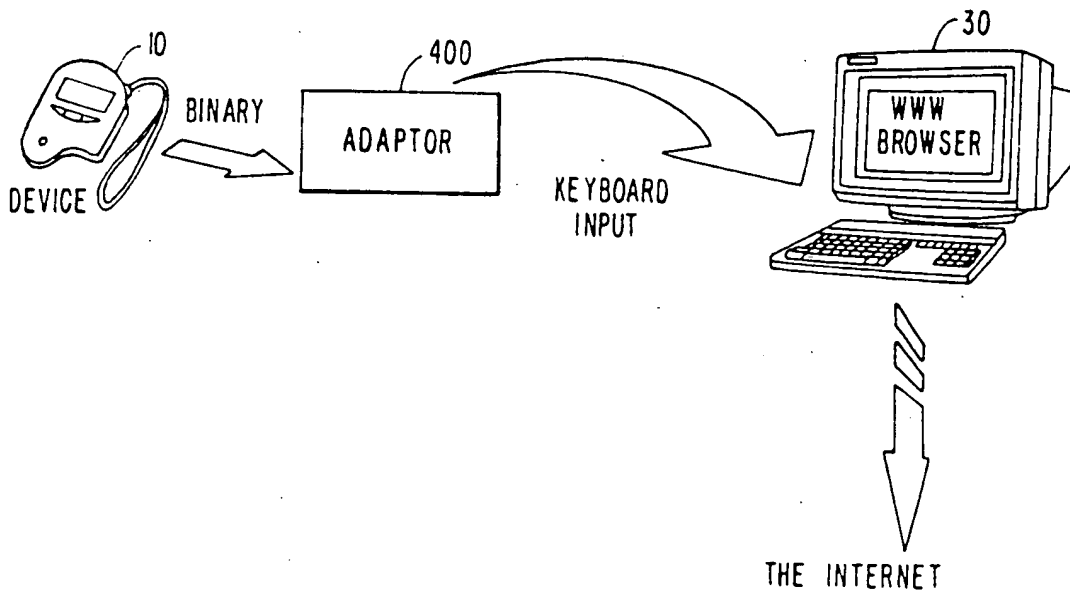

FIG. 4A.

5/11

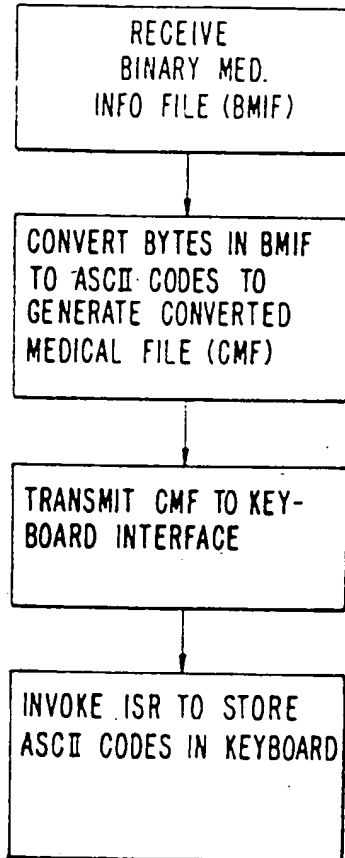

FIG. 4B.

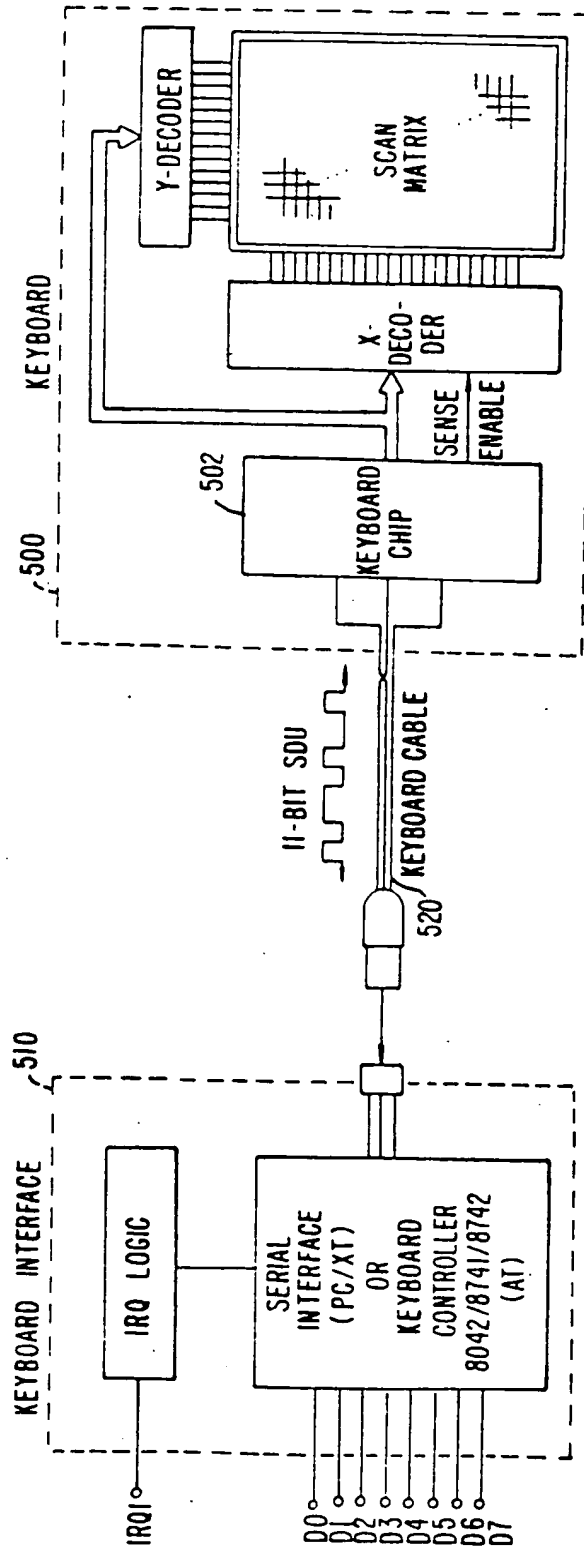

FIG. 5. PRIOR ART

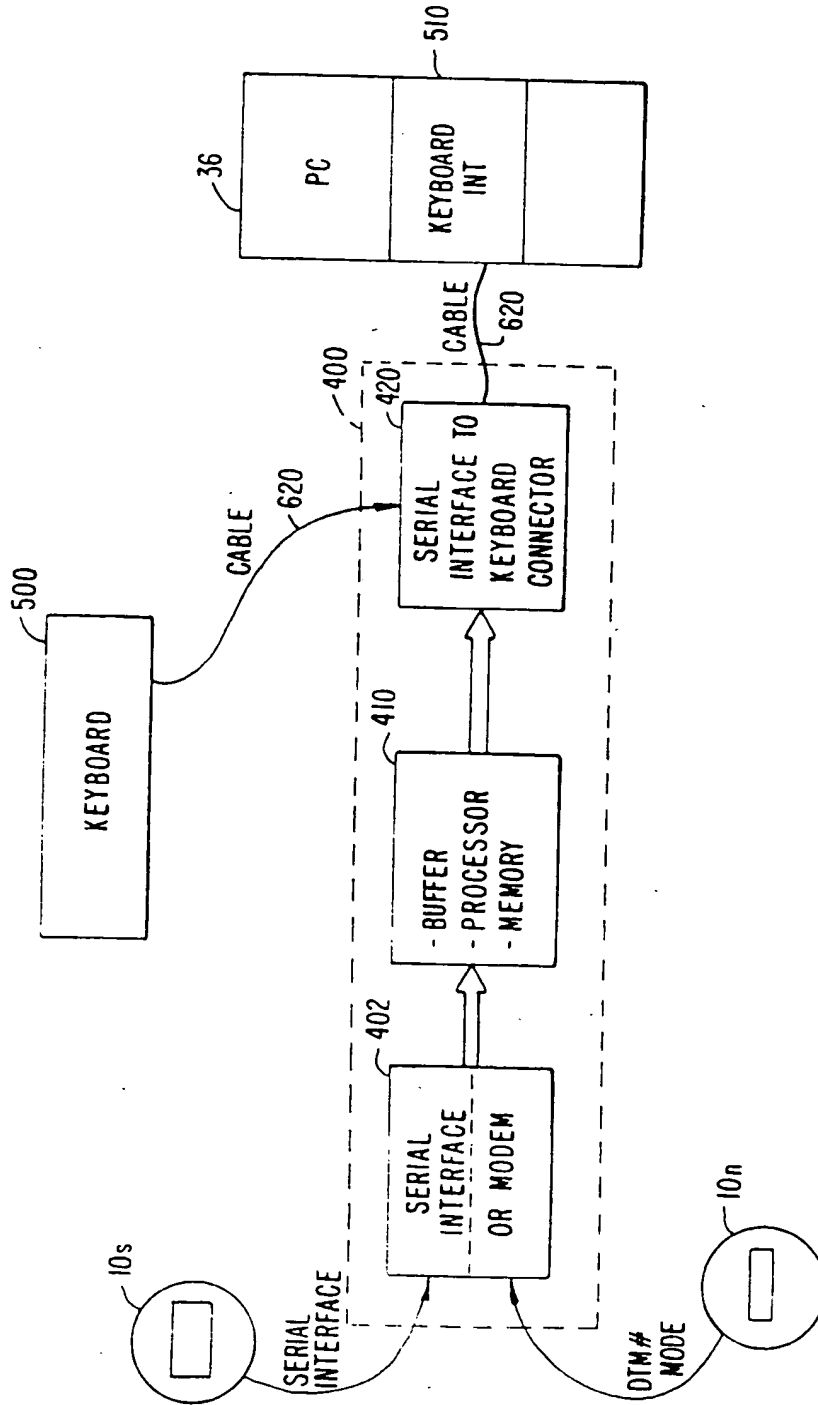

FIG. 6A.



8/11

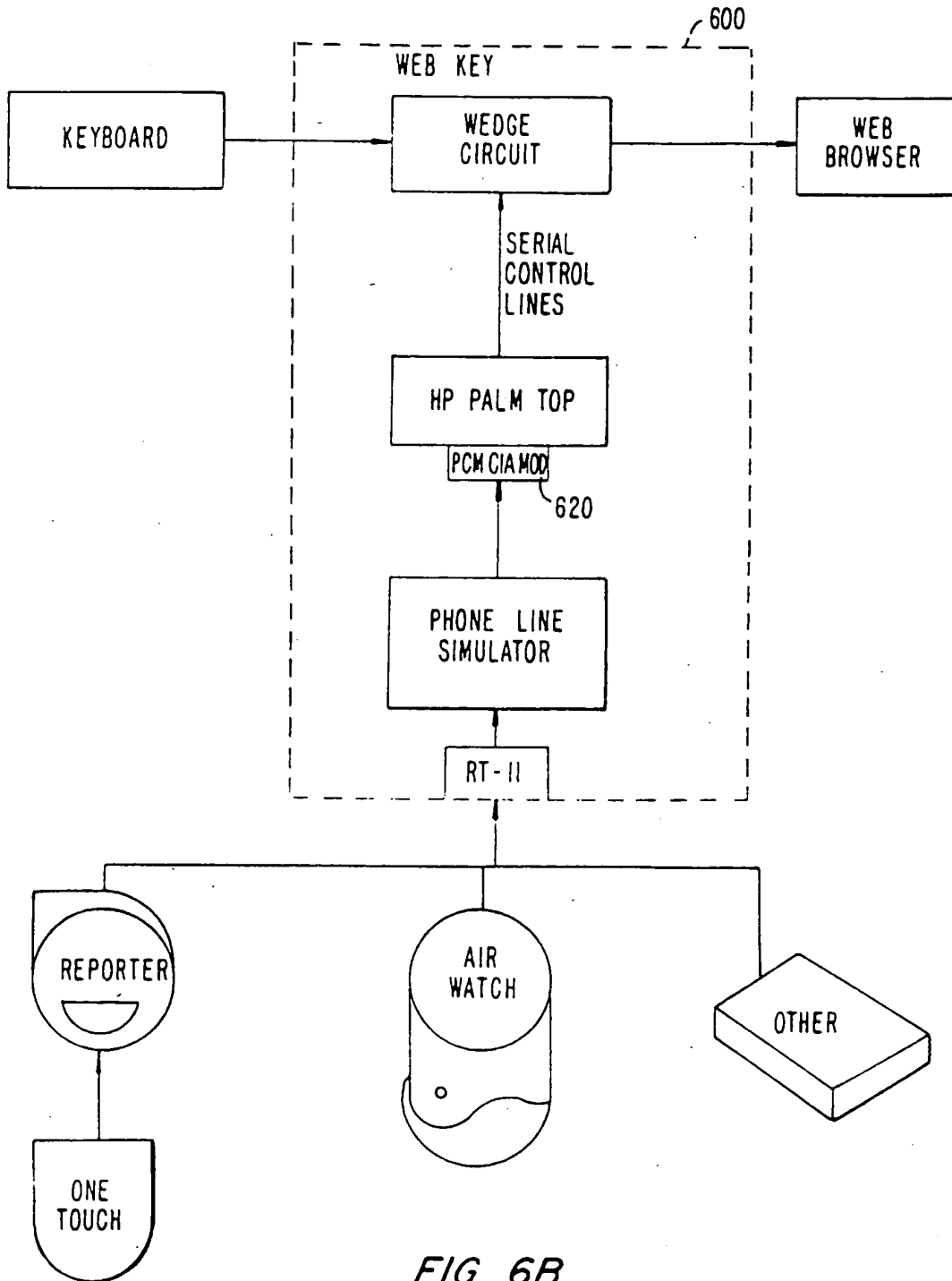

FIG. 6B.



10/11

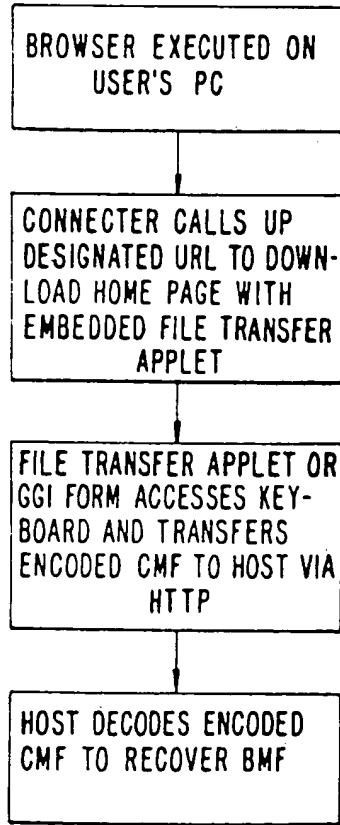

FIG. 7.

BEST AVAILABLE COPY

11/11

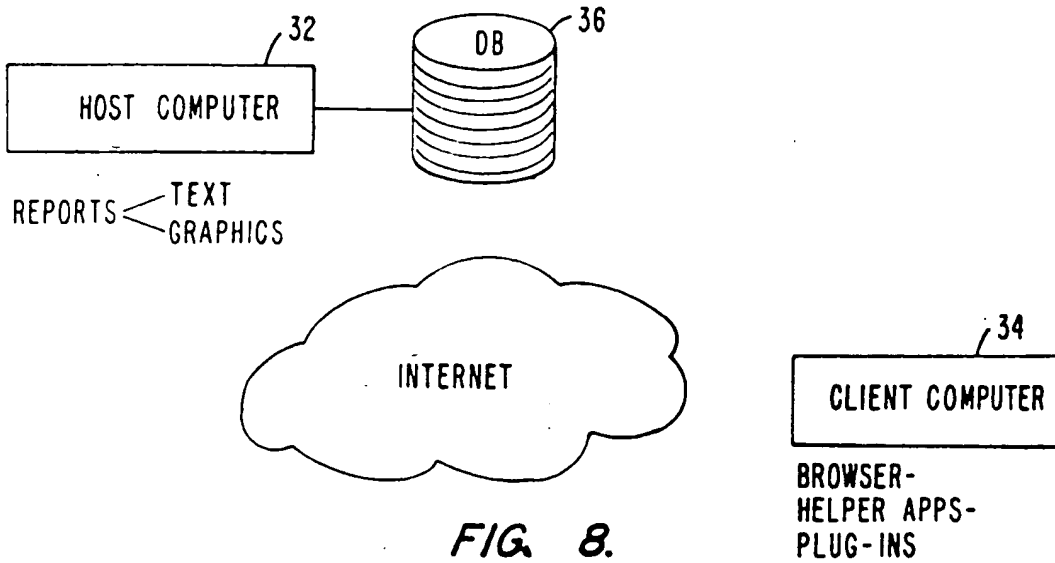

FIG. 8.

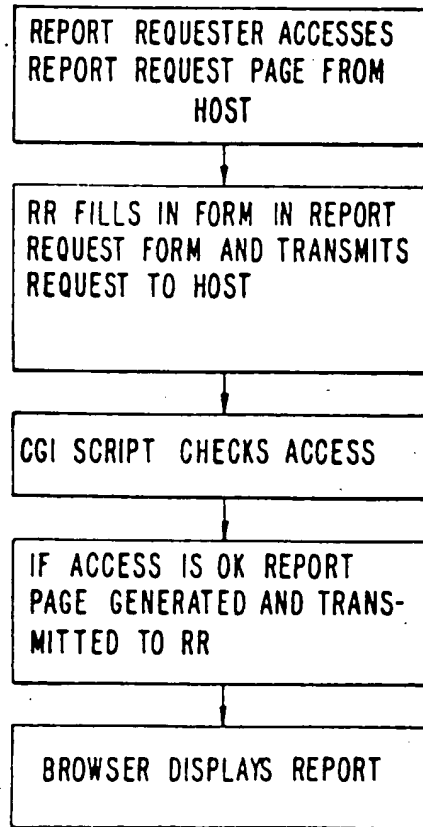

FIG. 9.

BEST AVAILABLE COPY